

WINDA BUDOWLANA DLA OSÓB I MATERIAŁÓW
RACK & PINION HOIST FOR MATERIALS

PTE500P

Kolumna o przekroju
trójkątnym i wysokiej
wytrzymałości

Heavy duty triangular mast

Akustyczny system
ostrzegawczy
Security acoustic warning
system

Zejście bezpieczeństwa

Security final descent

Wejście/Wyjście
z dwóch stron

Access/loading by 2 sides

Ogniwo obciążnikowe
Security loading cell

Siatka niegniotąca
bezpieczeństwa

Anti-crush security grid



WINDA BUDOWLANA DLA OSÓB I MATERIAŁÓW
RACK & PINION HOIST FOR MATERIALS

PTE500P

TRZYFAZOWA - THREEPHASE

Długość platformy Platform length	1.600 mm
Szerokość maksymalna Maximum width	1.100 mm
Prędkość Speed	12 m/min
Udźwig maksymalny Maximum load	500 Kg
Max wysokość Maximum Height	120 m
Moc silnika Output power	2,5 kW
Natężenie prądu Current intensity	6,3 A
Waga maszyny Weight machine	823 kg
Przekrój kolumny Kind of section	

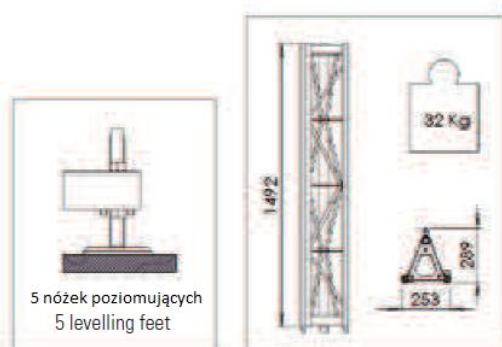

Moduł 5 - Module 5

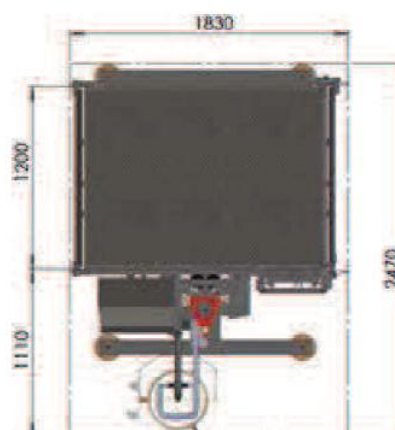
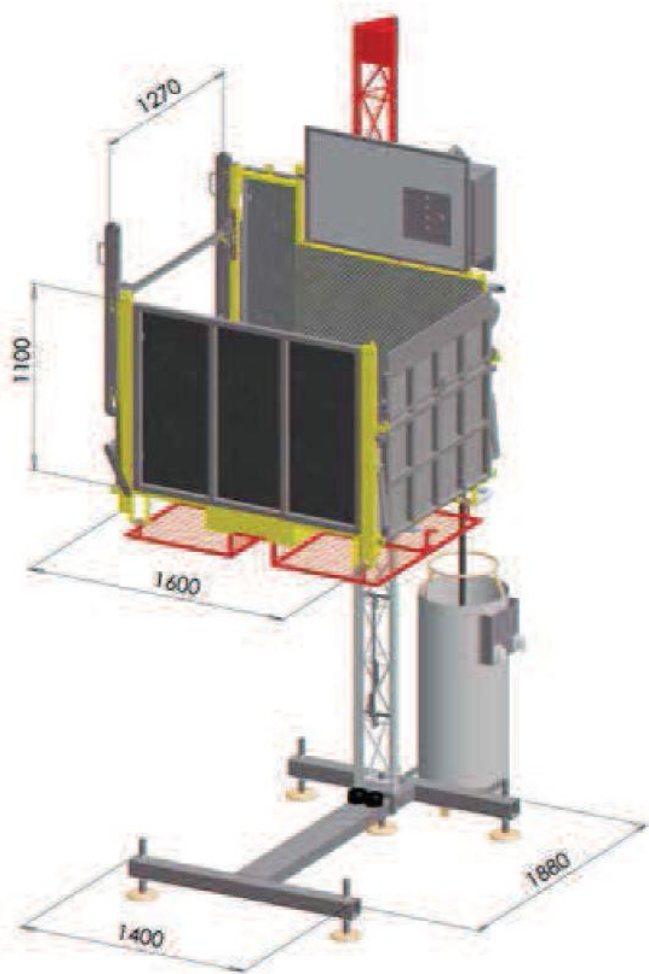

WINDA BUDOWLANA SAMOPODNOSZĄCA
PIATTAFORME AUTOSOLLEVANTI
ASCENSORI DA CANTIERE
RACK & PINION HOIST - MAST CLIMBING PLATFORM

wyciagarki.com

bellussi@bellussi.com.pl



WINDA BUDOWLANA DLA OSÓB I MATERIAŁÓW
RACK & PINION HOIST FOR MATERIALS

PTE500P

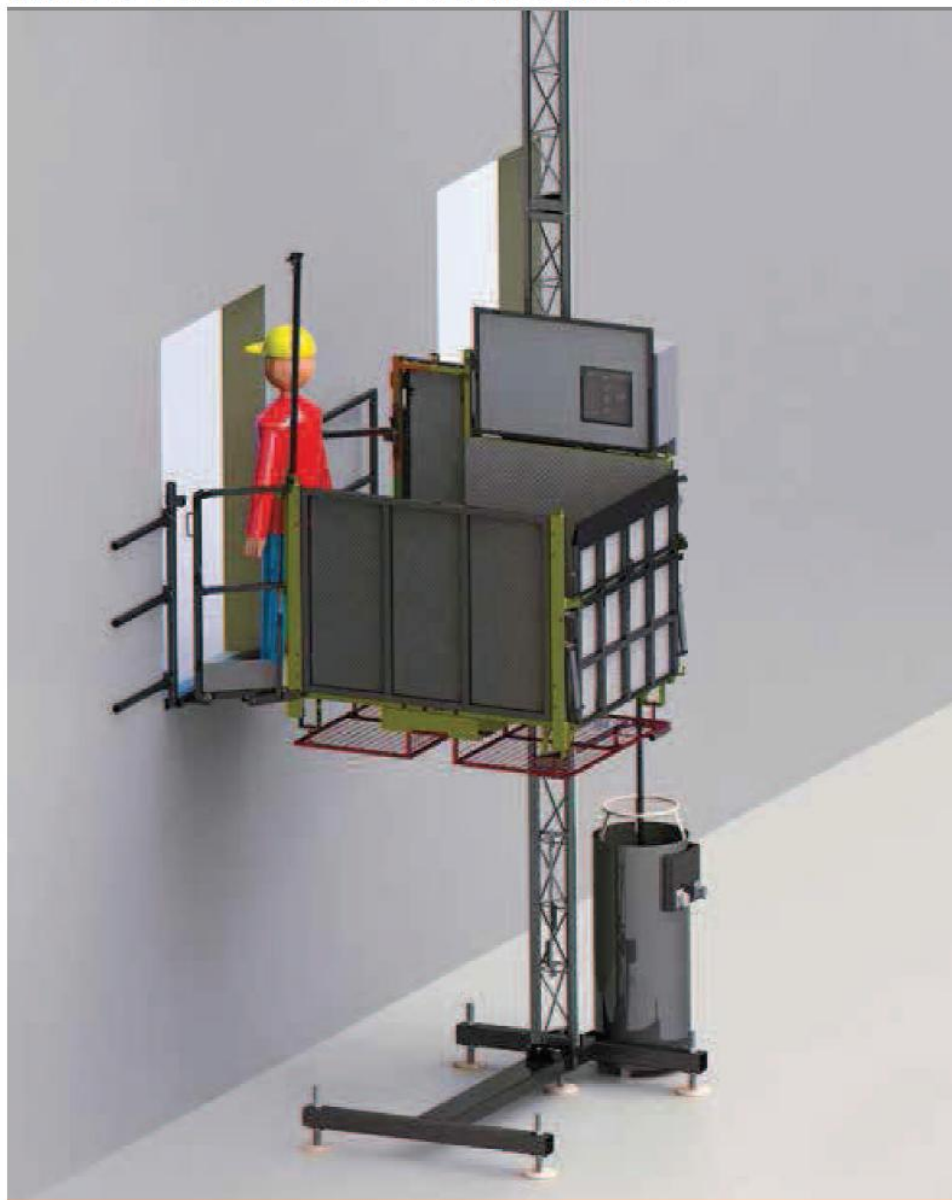

Przykład instalacji z mocowaniem do ściany i wyjściem przez otwór okienny.

Example of installation with fixation on wall and landing gate through a window or through a balcony.



Rozsuwany pomost dla łatwego montażu.

Telescopic gangway to facilitate assembling.

WINDA BUDOWLANA DLA OSÓB I MATERIAŁÓW
RACK & PINION HOIST FOR MATERIALS

PTE500P

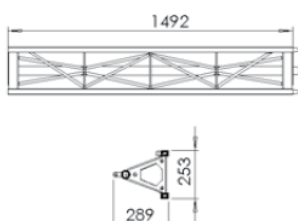

COD.	Nazwa / Name	Kg
PTE50000250	Kolumna standard 1,5 m Standard Mast 1,5 m	30

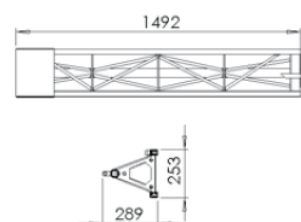

COD.	Nazwa / Name	Kg
PTE50000300	Kolumna końcowa Final Stop Mast	29

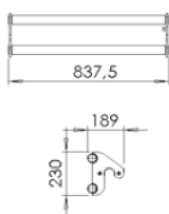

COD.	Nazwa / Name	Kg
PTE50001210	Wsparcie kotwy Anchorage tie	8

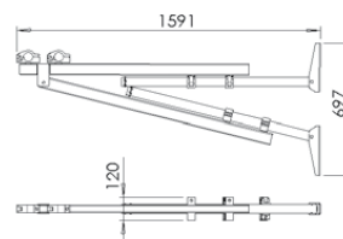

COD.	Nazwa / Name	Kg
PTE50001200	Kotwa regulowana Adjustable tilting anchorage	25

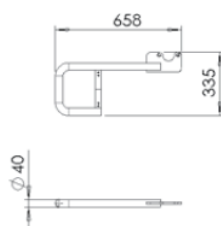

COD.	Nazwa / Name	Kg
PTE50001300	Prowadnica kabla Cable Guide	3,3

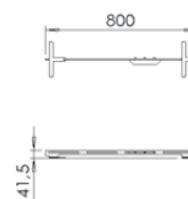

COD.	Nazwa / Name	Kg
PTE50000910	Przystanek Floor Stop	1,6

WINDA BUDOWLANA DLA OSÓB I MATERIAŁÓW
RACK & PINION HOIST FOR MATERIALS

PTE500P

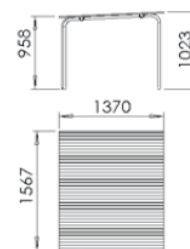
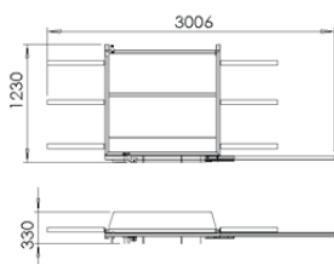

COD.	Nazwa / Name	Kg
PTE50001500	Bramka Floor Gate	52

COD.	Nazwa / Name	Kg
PTE50001400	Zadaszenie Basket Roof	37

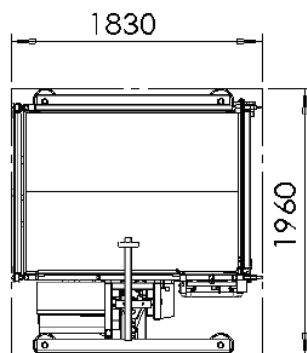
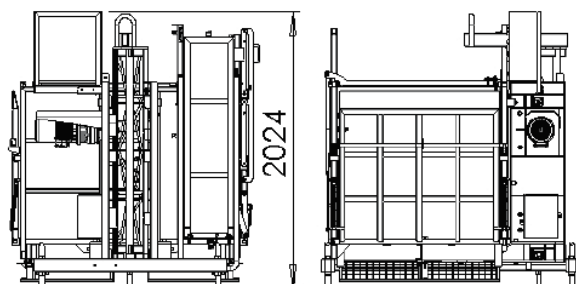

COD.	Nazwa / Name	Kg
PTE500P00	Wyposażenie bazowe / Basic Equipment	650